

1471 Electric Heater

User instructions for LED effect 2kw Heater

These instructions should be read carefully and retained for future reference

Important Notes

- This product is only suitable for well insulated spaces or occasional use
- Do not use this appliance as a primary heat source
- This heater must not be located immediately below a fixed socket outlet.
- Do not use the heater in the immediate surrounds of a bath, a shower, or a swimming pool.
- **Do not cover this heater, or obstruct the air inlet or outlet, otherwise there is a risk of overheating.** 
- Do not use outdoors
- The heater must be cooled down completely before any maintenance
- After unpacking, please make sure that the appliance is intact, with no signs of damage caused by transport. If in doubt, do not use the appliance and contact the Service Centre.
- During normal operation this appliance will emit noise from the internal fan unit.
- If the supply cord is damaged, it must be replaced by the manufacturer, its service agent or similarly qualified persons in order to avoid a hazard.
- Children should be supervised to ensure that they do not play with the appliance or handset
- Children of less than 3 years should be kept away unless continuously supervised. Children aged from 3 years and less than 8 years shall only switch on / off the appliance provided that it has been placed or installed in its intended normal operating position and they have been given supervision or instruction concerning use of the appliance in a safe way and understand the hazards involved. Children aged from 3 years and less than 8 years shall not plug in, regulate and clean the appliance or perform user maintenance.
- This appliance can be used by children aged from 8 years and above and persons with reduced physical, sensory or mental capabilities or lack of experience and knowledge if they have been given supervision or instruction concerning use of the appliance in a safe way and understand the hazards involved. Cleaning and user maintenance shall not be made by children without supervision
- Some parts of this product can become very hot and cause burns. Particular attention has to be given where children and vulnerable people are in the vicinity.
- Ensure that furniture, curtains and other combustible materials are positioned no closer than 1m from the front of the fire.
- Do not run cord under carpeting, do not cover cord with throw rugs, runners or the like. Arrange cord away from traffic areas and where it will not be tripped over.
- Do not insert or allow foreign objects to enter any ventilation or exhaust openings as this may cause electric shock, fire or damage the appliance
- Do not block air intakes or exhaust openings in any manner
- Do not use on soft surfaces such as a bed, where openings may become blocked
- If this fire is supplied through an extension cable, please ensure that it is the only appliance plugged into the extension and that the instructions for the extension cable / reel are followed.
- CAUTION: In order to avoid a hazard due to inadvertent resetting of the thermal cut out, this appliance must not be supplied through an external switching device, such as a timer, or connected to a circuit that is regularly switched on and off by the utility.
- This appliance must be positioned so that the plug / fused spur is accessible
- In the event of a fault please disconnect the fire from the mains supply
- Warning: This appliance must be earthed.

The wires in the mains lead connected to this appliance are coloured in accordance with the following code:

GREEN and YELLOW	Earth
BLUE	Neutral
BROWN	Live

As the colour of the wires in the mains lead of this appliance may not correspond with the coloured markings identifying the terminals in your plug, proceed as follows:

The wire which is coloured Green and Yellow must be connected to the terminal in the plug which is marked with the letter E or by the earth symbol or coloured Green or Green and Yellow. The wire which is coloured Blue must be connected to the terminal which is marked with the letter N or coloured Black. The wire which is coloured Brown must be connected to the terminal which is marked with letter L or coloured Red.

Please unpack carefully ensuring that any loose parts and all packing items are removed. Read any warning labels carefully (see maintenance section). Place waste packaging back into box and dispose of RESPONSIBLY.



The surround / appliance must be positioned so that plug (fused spur) is accessible. Only when you are certain that you have completed the installation should you plug in and switch on at the wall socket.

Suite Installation

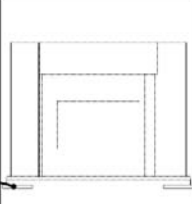
Parts Supplied

Ref	Description	Illustration	Qty
A	Suite with Electric Fire inc. Transit Pads		1

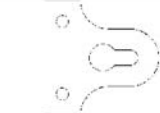
Fittings Supplied

Ref	Description	Illustration	Qty
B	Mirror Plates (if req.)		2
C	5/8" Screws (if req.)		4

Before You Start

- The appliance Data Plate is located Underneath the Heater-box Check and make sure you have all the parts as listed above. If not, contact: **Be-Modern Helpline on 0191 430 0901.**

Finishing Touches

Prior to installation please remove the transit pads at the base of the Suite "A" (If attached)

Place Suite "A" in the required position and remove any obstructions, i.e. cut to shape or remove skirting to allow the Suite to butt up flush against the wall (if required). Remember to allow enough space when cutting the skirting for the cable to exit from the desired side.

Tools Required for Wall Fixing suite mounted version. (Not supplied)

Drill, Cross Head Screwdriver, Wall plugs, Pencil, Ruler
Tape Measure, 2 Screws

Fixing suite to the Wall (If required)

1 - Screw the 2 off Mirror brackets (B) to the rear of each leg at 100mm from the top of the suite using the 4 - off 5/8" screws (C) see [Fig.1](#)

2 - Offer the suite to the wall and mark the wall with a pencil in the smaller hole of the mirror plate [Fig.2](#)

3 - Lift suite away from the wall then drill and plug the holes with suitable fixings dependant on types of wall.

4 - Offer the suite back to the wall and line up the mirror plates with the holes in the wall

5 - Fix to the wall using two screws (not supplied) See [Fig.2](#)

6 - N.B. This suite is supplied as a 1 piece product.

7 - Do not seal suite to the wall (I.e. using Silicone)

8 - The fire will be supplied installed into the surround. Remove the 2 x Transit screws going into the hearth from rear of the fire.

Should a defect occur and in the event of the suite being fixed to the wall, the householder should be aware of the following:-

They are fully responsible for the removal of the faulty suite and the fitting of the replacement. Any costs incurred during the removal and re-fitting of a replacement suite are the responsibility of the householder.

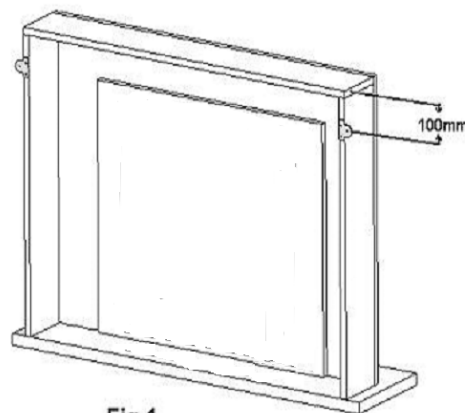

Fig.1

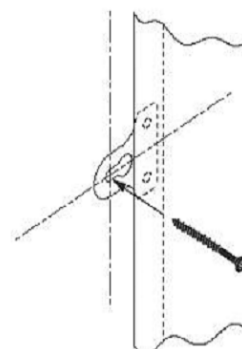

Fig.2

Please unpack carefully ensuring that any loose parts and all packing items are removed. Read any warning labels carefully (see Maintenance Section). Place waste packaging back into box and dispose of RESPONSIBLY.

The appliance must be positioned so that plug (fused spur) is accessible. Only when you are certain that you have completed the following installation should you plug in and switch on at the wall socket.

Preparation for Use

Check that the supply voltage details on your flame effect fire are in accordance with your electrical supply. Your fire is fitted with a plug incorporating a 13 Amp fuse. In the event of replacing the fuse in the plug supplied, a 13 Amp fuse approved by ASTA to BS 1362 must be used. Before switching on, please read the following operation instructions.

Fire Positioning

- Ensure that the inset dimensions match or exceed the dimensions in **Fig.1**
- Centralise the fire in the opening
- Gently push the fire backwards into the opening until it is flush against the wall / panel.
- The spring clips will keep the fire in position

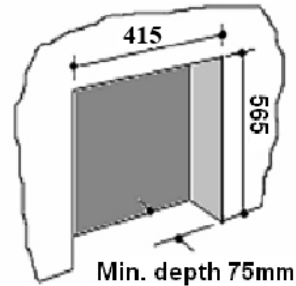

Fig.1

Thermostat

This model is fitted with a thermostat that is mounted on the right hand side of the stove unit. It can be used to control the heat output to maintain a constant room temperature to suit user requirements. This will ensure that excessive heat is not produced unnecessarily.

To set the temperature

The dial is marked with numbers to indicate the maximum and minimum temperature positions. Start with setting 9 and when the room has reached a desired level turn the dial slowly to the left until the thermostat 'clicks' off. The thermostat will then maintain the room temperature at the selected level. To increase the temperature, turn dial back to the right to a higher setting.

Note: It is possible that if the room temperature is higher than the thermostat setting it will not come into operation and the heater will remain off until the temperature of the room cools.

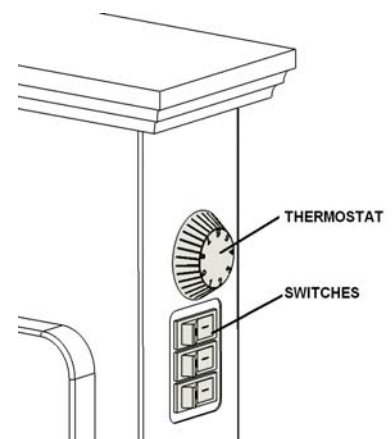

Manual 3 Switch Operation:

The Flame effect and heat controls are located on the right hand side of the stove unit.

- The first switch marked with a light bulb controls the lamp and flame effect as shown in **Fig.3**
- The next two switches operate the fan convector heater. To use the heater the middle of the three switches marked **O/I** (O is off, I is on) should be operated first for 1 kW of heat. The right hand switch also marked **O/I** should be used together with the middle switch to give 2kW of heat.

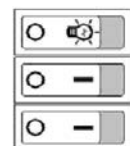

Note' lamp' switch must be in the 'on' position for heater to function.

Fig.3

Safety Thermal Cut-out and Thermal Link:

This appliance is fitted with an Electric Safety Control (E.S.). This is a safety device, which switches off the fire if, for any reasons, the appliance overheats. The E.S. Control can only be re-set after the appliance has cooled down, in Order to re-set the E.S. Control, proceed as follows:

- Switch off the appliance. Unplug from the wall socket and leave for approximately 5-10 minutes.
- Clean the filter unit as described in the care section of this instruction.
- Plug in switch on appliance and the E.S. Control will re-set.

Ensure that the appliance is functioning correctly. If the E.S. Control switches off again it is advisable to have the appliance checked by a competent electrician.

CAUTION: In order to avoid a hazard due to inadvertent resetting of the thermal cut out, this appliance **must not be** supplied through an external switching device, such as a timer, or connected to a circuit that is regularly switched on and off by the utility.

Using the fire as a portable appliance

Should you decide to use the appliance in a different location simply lift the fire vertically and towards to unhook from the keyhole brackets. Lift appliance away from the suite. The bracket / stands supplied with this appliance are to be fixed using the existing screws on the appliance and are to prevent the appliance falling over whilst in use.

Loosen the screws a couple of turns enough to enable you to slide the brackets into position. Once in position retighten the screws (see below). The appliance is now ready for use in another room / location

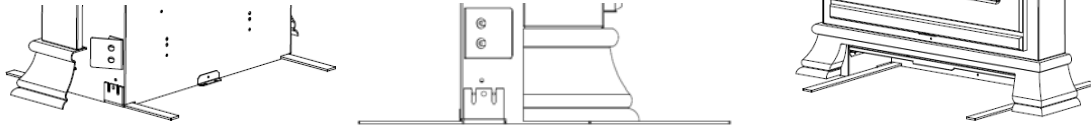

IMPORTANT This appliance must have the feet / brackets fitted to be used as a portable appliance. These feet / brackets are to prevent the fire from tipping over.

Maintenance:

WARNING: - Before undertaking any maintenance or cleaning, ensure appliance is disconnected from mains supply. Only competent persons should service / repair appliance.

WARNING: There are no internal user serviceable parts, i.e. bulbs in this product. Under no circumstance should access be gained to the internal parts other than by a suitably qualified person.

Please note: - If the supply cord on this appliance is damaged it must be replaced by the manufacturer, Authorised Service Agent, or a qualified person to avoid hazard.

Care:

Warning: Before undertaking any maintenance or cleaning disconnect appliance from main supply. Only competent persons should service / repair appliances.

Filter – Located underneath the stove

Dust build-up can inhibit efficient performance of the fan and lead to the safety cut-out operating. Periodic cleaning of the filter will ensure correct operation of the heater unit.

To remove the filter pull the filter unit towards the front of the fire, cleaning can be done with a vacuum cleaner and a suitable attachment **Fig. 4**.

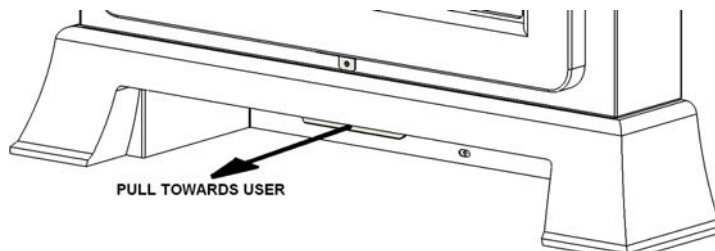

Fig 4.

General Suite Care – not glass

To maintain the appearance of your new suite we recommend that it is dusted using a lint free cloth. NEVER use any form of abrasives or a DAMP cloth on the fire or the surround.

The area around the fire should be kept free of any materials such as lint or house dust (i.e. animal hair/ carpet fibres) that could be drawn into the internal workings of the appliance and hence affect the performance. We recommend that you clean around the fan grille housing at regular intervals. This can be done using standard vacuum cleaner and suitable attachment.

Glass Care

Periodically it may be necessary to remove the door for cleaning. This is achieved by first disconnecting the appliance from the mains supply, then remove the screw directly underneath the door, this will allow the door to be removed by pulling the door initially vertically and the towards you, this will release the door from the keyhole slots used for location.

With the door removed the inside of the glass panel can be cleaned, when cleaning glass panels use a slightly damp cloth. Do not use washing powders or any other substance containing abrasives since these substances scratch glass.

Fault finding – Symptoms and cures

It is highly unlikely you should have a fault with your electric heater, but should there appear to be a problem, please refer to the following checklist of our most frequently asked questions from customers. If these do not answer your query, please contact your retailer, or call our customer service department.

No Flame Effect: Please check – does the heater still work? If Yes, - it will almost certainly need a LED unit (See Maintenance Section)

If No, - has the heater cut out operated? To protect against overheating please refer to the safety cut out paragraph. If still not working, first change the 13 Amp fuse in the plug with one you know works. Secondly, check the wall socket by plugging in a table lamp that you know has worked on another socket. If this does not work, get an electrician to check the socket.

Electric Fire Guarantee

Be Modern Ltd (the 'Company') provide a **twelve month** guarantee in respect of electric fire (the 'Product') ranges.

1. The twelve month Guarantee applies to:

- All 'Products' in the ranges manufactured by the 'Company' (but subject to exceptions below); where
- The 'Product' has been purchased and installed within the UK and in respect of
- The initial installation; and in favour of
- The original Purchaser

2. Proof of purchase must be retained by the Purchaser

3. The twelve month Guarantee does not apply to:

- Damage or inferior workmanship practices while the 'Product' is being installed
- Damage caused by the mis-use of the 'Product' or where normal standards of care and use have not been complied with.
- Damage through a malfunction or an inadequately installed electric fire.
- Damage or defects due to, mis-use, accident or unauthorised alterations.

During the **twelve month** after the 'Product' has been supplied, the Guarantee covers the making good (whether by repair or replacement at the company's option) of defects arising from defective manufacture of materials of 'Product' covered in paragraph (1), all at no cost to the Purchaser.

This Guarantee does not affect your statutory rights

On requiring service contact the retailer who supplied your product who will assist you and advise you as necessary.



This fire complies with the European Safety Standards (LVD) EN60335-1, EN60335-2-30, the European Electro Magnetic Compatibility (EMC) EN55014, EN61000 and EN62233 which covers the essential requirements of the EEC Directives and 89/336

Be Modern Group, Customer Services
Tel (0191) 430 0901 - Fax (0191) 430 9522

Waste electrical products should not be disposed of with household waste. Please recycle where facilities exist. Check with your local authority or retailer for recycling advice.



Table 2

Information requirements for electric local space heaters

Model identifier(s):		1471			
Item	Symbol	Value	Unit	Item	Unit
Heat Output				Type of heat input, for electric storage local space heaters only (select one)	
Nominal heat output	P_{nom}	2.0	kW	manual heat charge control, with integrated thermostat	[yes/ no]
Minimum heat output (indicative)	P_{min}	1.0	kW	manual heat charge control with room and/or outdoor temperature feedback	[yes/no]
Maximum continuous heat output	$P_{max, c}$	2.0	kW	electronic heat charge control with room and/or outdoor temperature feedback	[yes/no]
Auxiliary electricity consumption				fan assisted heat output	
At nominal heat output	el_{max}	0.0125	kW	Type of heat output/room temperature control (select one)	
At minimum heat output	el_{min}	0.012	kW	Single stage heat output and no room temperature control	[yes/no]
In standby mode	el_{SB}	0.0003	kW	Two or more manual stages, no room temperature control	[yes/no]
				with mechanic thermostat room temperature control	[yes/ no]
				with electronic room temperature control electronic room temperature control plus day timer	[yes/no]
				electronic room temperature control plus week timer	[yes/no]
				Other control options (multiple selections possible)	
				room temperature control, with presence detection	[yes/no]
				room temperature control, with open window detection	[yes/no]
				with distance control option	[yes/no]
				with adaptive start control	[yes/no]
				with working time limitation	[yes/no]
				with black bulb sensor	[yes/no]
Contact details	Name and address of the manufacturer or its authorised representative. Be Modern Ltd, 19-34 Bedesway, Bede Industrial Estate, Jarrow, NE34 3BE				